

SS120W Instructions

SPECIFICATIONS

120 WATT DIGITAL TRANSFORMER

INPUT: 120VAC 60Hz 1.0A

MAX RATING: 120VA max

Output: 12VAC/15VAC

MODEL: ELS-GM-0120-120M12-SS-A

P/N: SS120W

SAFETY INFORMATION

1. Do not install within 10 feet (3m) of a pool, spa, or fountain.
2. This transformer is suitable for mounting within 12 in. to 48 in. (0.3m to 1.2m) of the ground.
3. For use with a low voltage outdoor landscape lighting system.
4. There are no serviceable parts inside the power supply unit. **DO NOT DISASSEMBLE.**
5. Do not submerge transformer.
6. Do not connect two or more transformers in parallel.
7. Do not use with a dimmer.
8. Plug the power supply unit directly into a GFCI wet location outlet.
9. Do not use an extension cord.
10. The maximum output of this transformer is equal to or less than 120 watts. Do not overload the transformer. Be sure that the total cumulative wattage of all 12-15volt fixtures connected to the transformer is equal to or less than 120 watts. Total bulb wattage must not exceed a maximum of 120 watts.
11. For best performance, and to limit operation of the automatic thermal protector, do not install where air flow around the unit is overly restricted.
12. For supply connections, use wire rated for at least 60°C.
13. Keep enclosure cover closed.
14. Suitable for Use with Submersible Luminaires or Submersible Pumps or equivalent.



WARNING: Risk of Electric Shock. Install power unit 5 feet (1.5m) or more from a pool, spa, or fountain. Where the power unit is installed (a) indoors within 10 feet (3.0m) of a pool, spa, or fountain or (b) outdoors, connect power unit to a receptacle protected by a GFCI.



WARNING: For outdoor installations use UL Listed Underground low energy circuit cable or SPT-3 or SPT-2W. Failure to use at least 16-gauge minimum cable or install it as directed in these instructions may result in Risk of Fire or Electric Shock. Using large cable will ensure maximum light output.



WARNING: Changes or modifications to this unit not expressly approved by the party responsible for compliance could void the user's authority to operate the equipment.



IMPORTANT: This landscape light system must be installed in accordance with all local codes and ordinances. If you are experiencing problems, contact a qualified electrician.

PRE-INSTALLATION

Hardware Included

 **NOTE:** Hardware not shown to actual size.

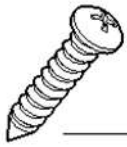

AA



BB



CC

Part	Description	Quantity
AA	5.0X50 Screw	2
BB	Wall Anchor	2
CC	Mounting Template	1

INSTALLATION

1. Preparing the cable

- ◇ Use caution when splitting to avoid exposing copper wire.
- ◇ Remove 1/2 in. of insulation from both wires and twist the ends. Refer to the strip-length guide on the Transformer (A).

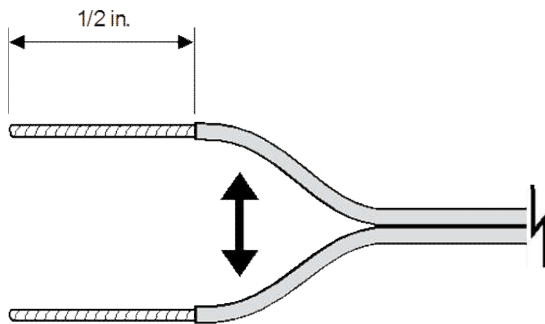

3. Layout Garden Light

- ◇ Lay the fixtures (not included) in their desired locations. Be sure they do not exceed the 200-watt rating of the transformer.
- ◇ Route the low voltage cable to the fixtures. If there is extra cable, coil the cable after the last fixture.

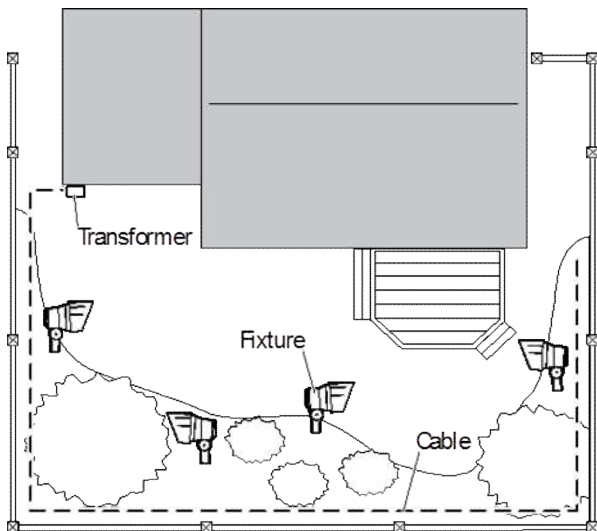

2. Connect Cable

- ◇ Lay the transformer on a flat, stable surface and insert the stripped end of one wire under the terminal clamping plate COM 12V 15V then tighten the **screw**.

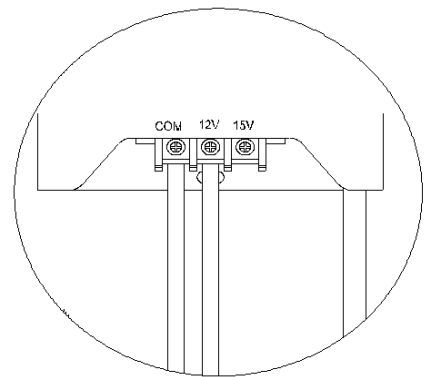

4. Mounting the transformer

- ◇ Turn the transformer on. Attach your fixtures to the cable to using cable connectors as shown.

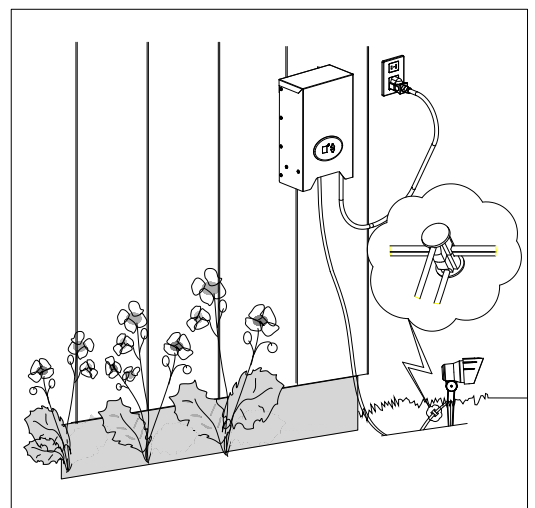

Programming

1. Setting PHOTOCCELL AUTO ON/OFF

- ◇ Press ↑ or ↓ for 3 secs, and select the "A".
- ◇ Enter the AUTO Photocell mode after "A" flashes for 5 secs
- ◇ The start delay time is 0.1 sec. ± 1 sec. ;
The off delay time is 60 sec. ± 10 sec.

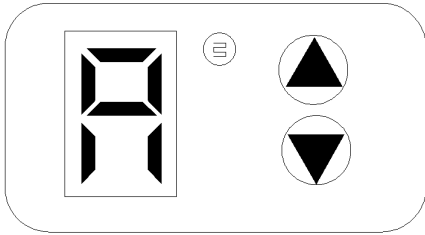

FIG.1

3. Setting the TIME ON/OFF

- ◇ Press ↑ or ↓ for 3 secs, and the select "1-9" timer mode. Press ↑ to add the timing time ↓ to reduce the timing time. Enter the timer mode after "1-9" flashes for 5 secs.
- ◇ The time tolerance is ±3 seconds per hour.

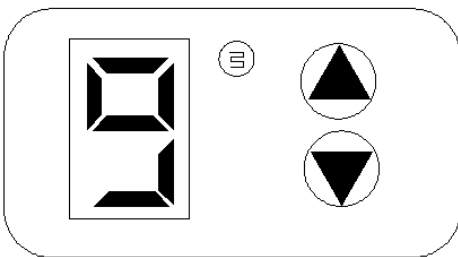

FIG.3

2. Operating in Manual Mode

- ◇ Press ↑ or ↓ for 3 secs, and the select "□".
- ◇ Enter the Manual mode after "□" flashes for 5 secs. Press ↑ to open and press ↓ to close.

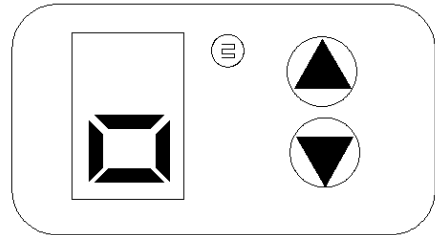

FIG.2

4. Using the TEST function

- ◇ Press ↑ or ↓ for 3 secs, and select the "[".
- ◇ Enter the TEST mode after "[" flashes for 5 secs.
- ◇ The time of photocell feeling the external light signal: the lights will turn on at dusk and off at dawn within 0.5 seconds .

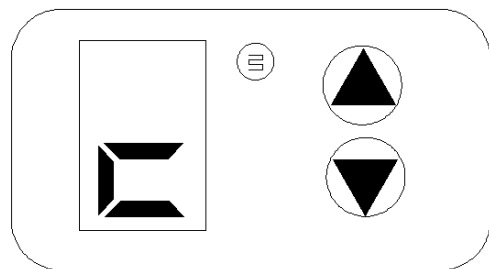

FIG.4

