

ML75S24AC

Class 2 Magnetic Phase cut Dimmable

Outdoor Black Powder Coated Steel Enclosure

Single Circuit: **24VAC**

Total Wattage: **75W max**

Input Voltage: **120V 60Hz**



Conforms to UL STD. 1310
Certified to CSA
STD. C22.2 No 223
model EM75
[Link to certification](#)

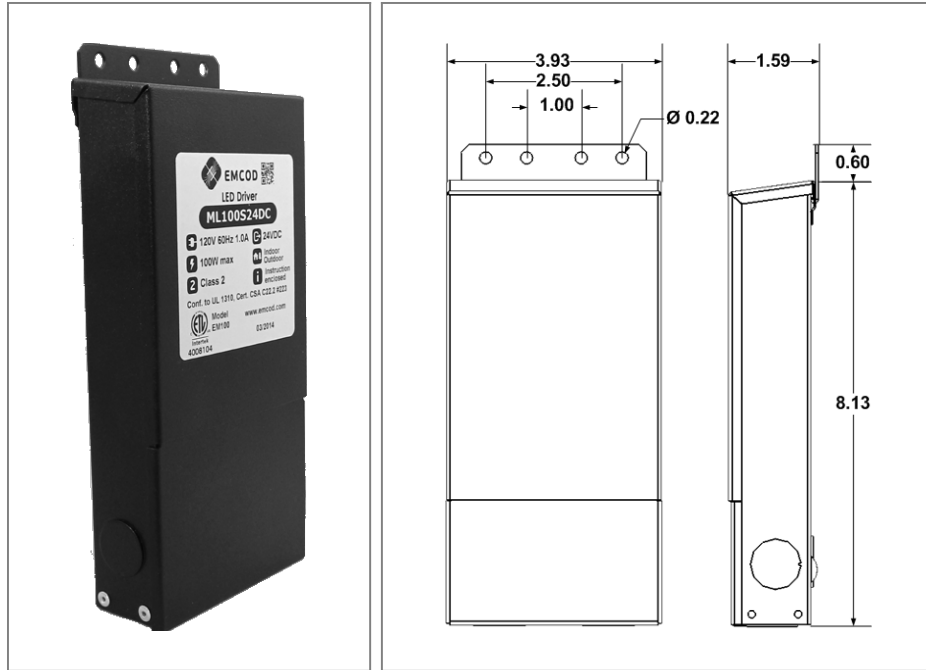

Transformer

Dimmable with compatible MLV, ELV, CL dimmers, please refer to list on emcod.com

Temperature class B(130°C)

Input leads are 18AWG 600V

Output leads are 18AWG 300V

Leads max. operational temperature is 105°C

Thermal manually reset primary breaker 1A

Thermal manually reset secondary breaker 5A

Housing

The actual transformer 75W is encapsulated in the enclosure

The enclosure is Black Powder Coated Steel, NEMA 3R rated

Wiring compartment has 3 knockouts sizes for 3/8 inch screw cable connectors

Enclosure Temperature does not exceed 75°C at 45°C ambient and fully loaded

Dimensions (inch): H = 8.13, W = 3.93, D = 1.59

Weight (LBs): 4.35

Electrical Parameters

Input Voltage: **120V 60Hz**

Max. input current at full load: **0.75A**

Output voltage without load: **27.2VAC**

Output voltage fully loaded: **23.5VAC**

Max. Total Wattage: **75W**

Max. Output Current: **3.2A**

Efficiency: **85%**

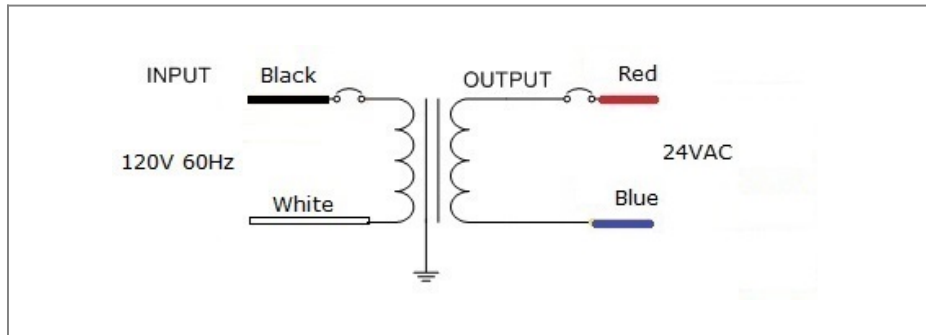

Mailing Address: 646 Flinn Ave. Unit B, Moorpark, CA 93021 Tech support: Arik Nirenberg phone: 818-904-3309

Fax: 818 904 3327 info@emcod.com techsupport@emcod.com